

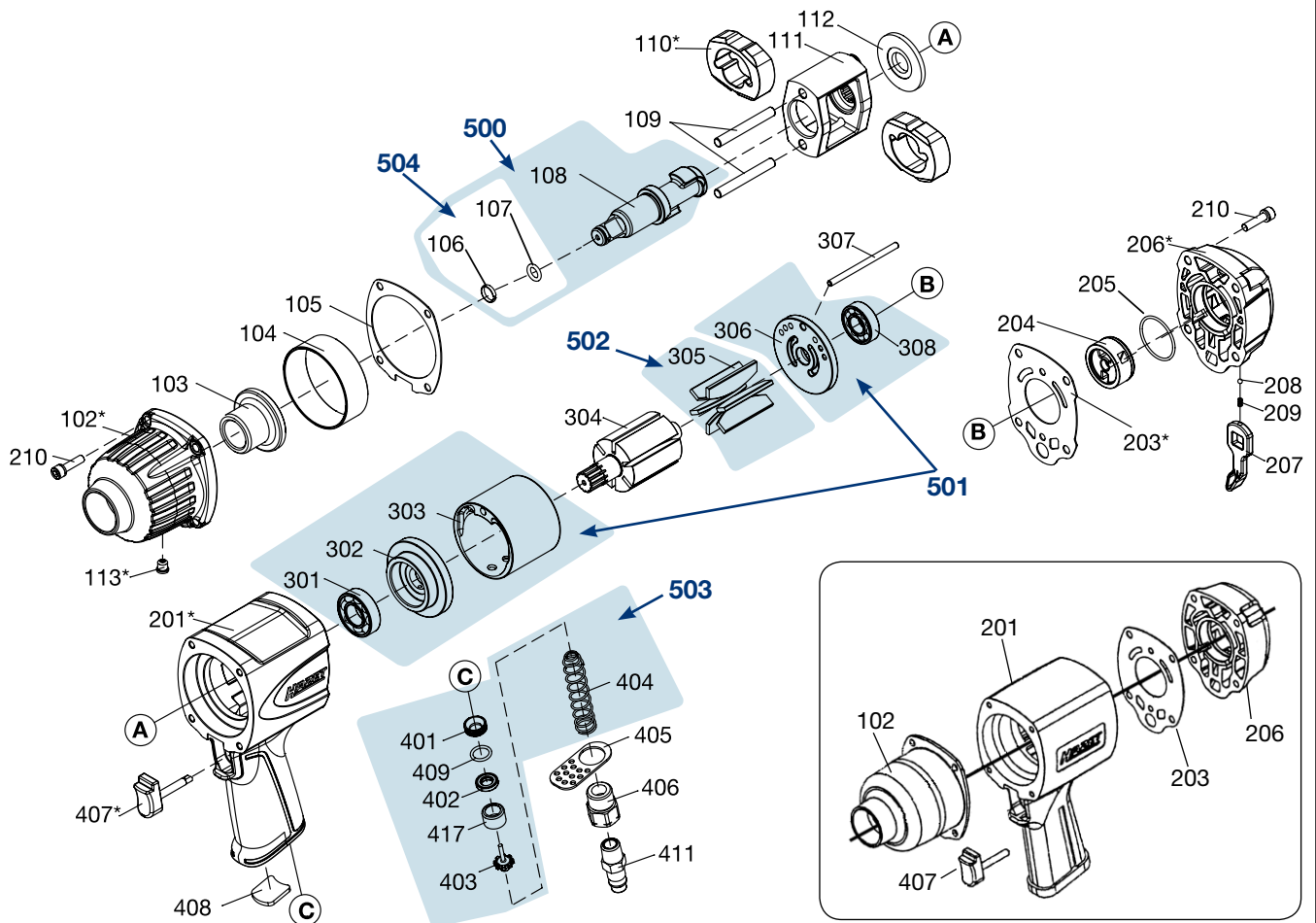



# Erersatzteile 9012 MG









	HAZET No.	Bezeichnung	Name	Désignation	
102	9012MG-03	Schlagwerkgehäuse	Hammer case	Boîtier de mécanisme de frappe	1
102*	9012MG-03N	Schlagwerkgehäuse	Hammer case	Boîtier de mécanisme de frappe	1
		Inhalt: 102, 113* Schmiernippel	Contents: 102, 113* Lubricating nipple	Contenu: 102, 113* Lubri- cating nipple	
103	9012MG-04	Schlagwerkbuchse	Hammer case bushing	Douille de mécanisme de frappe	1
104	9012MG-05	Distanzscheibe	Hammer case pilot	Disque d'entretoise	1
105	9012MG-06/5	Gehäusedichtung	Hammer case gasket	Point de boîtier	1
109	9012MG-07	Stift	Hammer frame pin	Goupille	2
110	9012MG-08/2	Schlagwerk	Hammer	Mécanisme de frappe	2
111	9012MG-09	Schlagwerkkorb	Hammer frame	Cage de mécanisme de frappe	1
112	9012MG-010/5	Scheibe	Washer	Rondelle	1
201	9012MG-011	Gehäuse	Housing	Boîtier	1
201*	9012MG-011N	Gehäuse	Housing	Boîtier	1
203	9012MG-012/10	Gehäuse-Dichtring	Housing gasket	Joint d'étanchéité de boîtier	1
203*	9012MG-012/10N	Gehäuse-Dichtring	Housing gasket	Joint d'étanchéité de boîtier	1

	<b>HAZET</b> No.	<b>Bezeichnung</b>	<b>Name</b>	<b>Désignation</b>	
204	9012MG-013	Steuerungsventil	<i>Reverse valve</i>	<i>Valve de commande</i>	1
205	9012MG-014/15	O-Ring	<i>O - Ring</i>	<i>Joint torique</i>	2
206	9012MG-015	Hintere Gehäuseabdeckung	<i>Rear cover unit</i>	<i>Capot de boîtier arrière</i>	1
206*	9012MG-015N	Hintere Gehäuseabdeckung	<i>Rear cover unit</i>	<i>Capot de boîtier arrière</i>	1
207	9012MG-016/5	Hebel	<i>Lever</i>	<i>Levier</i>	1
208	9012MG-017/15	Kugel	<i>Ball</i>	<i>Bille</i>	1
209	9012MG-018/15	Feder	<i>Spring</i>	<i>Ressort</i>	1
210	9012MG-019/8	Gehäuseschraube	<i>Bolt assy</i>	<i>Vis de boîtier</i>	8
304	9012MG-020	Rotor	<i>Rotor</i>	<i>Rotor</i>	1
307		Stift	<i>Pin</i>	<i>Goupille</i>	1
405	9012MG-021/5	Luftleitblech	<i>Exhaust deflector</i>	<i>Déflexeur d'air</i>	1
406	9012MG-022	Lufteinlaß	<i>Air inlet</i>	<i>Admission d'air</i>	1
407	9012MG-023	Abzugshebel	<i>Trigger</i>	<i>Levier de tirage</i>	1
407*	9012MG-023N	Abzugshebel	<i>Trigger</i>	<i>Levier de tirage</i>	1
408	9012MG-024/15	Auslaßsieb	<i>Muffler</i>	<i>Tamis d'échappement</i>	1
500	9012 MG-01/3	Vierkant	<i>Anvil</i>	<i>Carré</i>	1
		Inhalt: 106, 107, 108	<i>Contents: 106, 107, 108</i>	<i>Contenu: 106, 107, 108</i>	
501	9012 MG-01/5	Zylindereinheit	<i>Cylinder-Set</i>	<i>Unité de vérin</i>	1
		Inhalt: 301, 302, 303, 306, 308	<i>Contents: 301, 302, 303, 306, 308</i>	<i>Contenu: 301, 302, 303, 306, 308</i>	
502	9012 MG-01/6	Lamellen	<i>Blades</i>	<i>Lamelles</i>	1
		Inhalt: 305 (6)	<i>Contents: 305 (6)</i>	<i>Contenu: 305 (6)</i>	
503	9012 MG-02/6	Ventileinheit	<i>Valve-Set</i>	<i>Unité de soupape</i>	1
		Inhalt: 401, 402, 403, 404, 409, 417	<i>Contents: 401, 402, 403, 404, 409, 417</i>	<i>Contenu: 401, 402, 403, 404, 409, 417</i>	
504	9012MG-01/2	Ringe	<i>Rings</i>	<i>Joint torique</i>	1
		Inhalt: 106, 107	<i>Contents: 106, 107</i>	<i>Contenu: 106, 107</i>	
		* Ersatzteil für neue Ausführung / neues Design ab 2013	<i>* Spare part for new version / new design from 2013</i>	<i>* Pièce détachées pour nouvelle génération / nouveau design depuis 2013</i>	

Positionen, die keine **HAZET** Material-No. haben, sind über den HAZET-Service zu erhalten

Zur Bestellung und für Rückfragen wenden Sie sich bitte an unsere Service-Abteilung.  
 +49 (0) 21 91/7 92 355 •  +49 (0) 21 91/7 92 523 •  service-center@hazet.de

**HAZET - WERK Hermann Zerver GmbH & Co. KG** •  10 04 61 • D-42804 Remscheid • Germany  
 Gùldenwerther Bahnhofstraße 25 - 29 • D-42857 Remscheid •  www.hazet.de •  info@hazet.de  
 +49 (0) 21 91 / 7 92-0 •  +49 (0) 21 91 / 7 92-375 (National) •  +49 (0) 21 91 / 7 92-400 (International)