

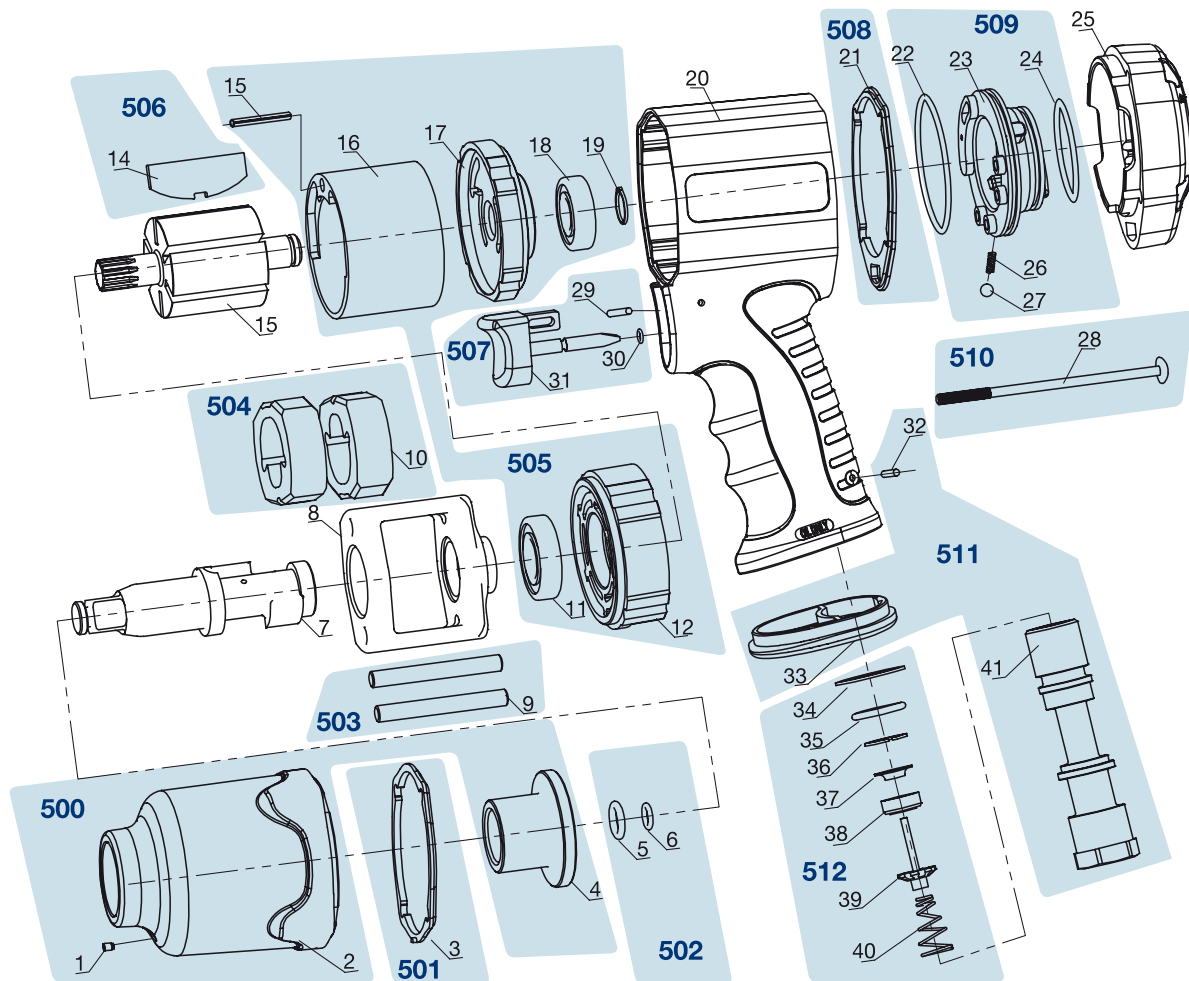

Erersatzteile 9012 X





	HAZET No.	Bezeichnung	Designation	Désignation	
7	9012 X-01	Vierkant	Anvil	Carré de rechange	1
8	9012 X-02	Schlagwerkkorb	Hammer frame	Cage de mécanisme de frappe	1
13	9012 X-03	Rotor	Rotor	Rotor	1
20	9012 X-04	Gehäuse	Housing	Boîtier	1
25	9012 X-05	Hintere Gehäuseabdeckung	Rear cover unit	Capot de boîtier arrière	1
500	9012 X-06/3	Vorderes Gehäuse Inhalt: 1, 2, 4	Front Housing Contents: 1, 2, 4	Boîtier avant Contenu : 1, 2, 4	3
501	9012 X-07/5	Gehäusedichtung Inhalt: 3 (5x)	Housing gasket Contents: 3 (5x),	Joint de boîtier Contenu : 3 (5x)	5
502	9012 X-08/2	Ring Satz Inhalt: 5, 6,	Ring Set Contents: 5, 6,	Jeu d'anneaux Contenu : 5, 6,	2
503	9012 X-09/2	Stift Satz Inhalt: 9 (2x)	Hammer frame pin set Contents: 9 (2x)	Jeu de goupilles Contenu : 49 (2x)	2
504	9012 X-010/2	Schlagwerk Satz Inhalt: 10 (2x)	Hammerset Contents: 10 (2x)	Jeu de mécanisme de frappe Contenu : 10 (2x)	2

	HAZET No.	Bezeichnung	Designation	Désignation	
505	9012 X-011/7	Zylindereinheit	<i>Cylinder unit</i>	<i>Unité de vérin</i>	7
		Inhalt: 11, 12, 15, 16,17, 18, 19	<i>Contents: 11, 12, 15, 16, 17, 18, 19</i>	<i>Contenu : 11, 12,15, 16, 17, 18, 19</i>	
506	9012 X-012/6	Lamellen	<i>Rotor Blades</i>	<i>Lamelles</i>	6
		Inhalt: 14 (6x)	<i>Contents: 14 (6x)</i>	<i>Contenu : 14 (6x)</i>	
507	9012 X-013/3	Abzugshebel	<i>Trigger unit</i>	<i>Levier de tirage</i>	3
		Inhalt: 29, 30, 31	<i>Contents: 29, 30, 31</i>	<i>Contenu : 29, 30, 31</i>	
508	9012 X-014/5	Hintere Gehäusedichtung	<i>Rear Housing gasket</i>	<i>Joint de boîtier arrière</i>	1
		Inhalt: 21 (5x)	<i>Contents: 21 (5x)</i>	<i>Contenu : 21 (5x)</i>	
509	9012 X-015/5	Umschalter	<i>Toggle swich set</i>	<i>Jeu de commutateurs</i>	5
		Inhalt: 22, 23, 24, 26, 27	<i>Contents: 22, 23, 24, 26, 27</i>	<i>Contenu : 22, 23, 24, 26, 27</i>	
510	9012 X-016/4	Gehäuseschrauben Satz	<i>Housing screw set</i>	<i>Jeu de vis de boîtier</i>	4
		Inhalt: 28 (4x)	<i>Contents: 28 (4x)</i>	<i>Contenu : 28 (4x)</i>	
511	9012 X-017/3	Luftinlass	<i>Air inlet</i>	<i>Admission d'air</i>	3
		Inhalt: 32, 33, 41	<i>Contents: 32, 33, 41</i>	<i>Contenu : 32, 33, 41</i>	
512	9012 X-018/7	Ventileinheit	<i>Valve Unit</i>	<i>Unité de soupape</i>	7
		Inhalt: 34, 35, 36, 37, 38, 39, 40	<i>Contents: 34, 35, 36, 37, 38, 39, 40</i>	<i>Contenu : 34, 35, 36, 37, 38, 39, 40</i>	







Positionen, die keine **HAZET** Material-No. haben, sind nur über den HAZET-Service zu erhalten



Zur Bestellung und für Rückfragen wenden Sie Sich bitte an unsere Service-Abteilung.
 +49 (0) 21 91/7 92 355 •  +49 (0) 21 91/7 92 523 •  service-center@hazet.de

www.hazet.de/
de/home/service/
pneumatikmaschinen/

www.hazet.de/
ersatzteil-shop/

HAZET - WERK Hermann Zerver GmbH & Co. KG •  10 04 61 • 42804 Remscheid • GERMANY
 +49 (0) 21 91 / 7 92-0 •  +49 (0) 21 91 / 7 92-375 (National) •  +49 (0) 21 91 / 7 92-400 (International)
 Gùldenwerther Bahnhofstraße 25 - 29 • 42857 Remscheid • GERMANY •  hazet.de •  info@hazet.de