









⊕ "Loctite 222 frein file"

⊕ 13 / 18		1,4 N.m
⊕ 23 / 11		35 N.m
⊕ 35 / 11		35 N.m
29 / 34		8 N.m
29 / 18		8 N.m
22 / 18-34		10 N.m
⊕ 1 / 11		25 N.m
25 / 18-34		10 N.m
⊕ 24 / 11		35 N.m

↻ Tightening direction
Sens de serrage
Sentido de apriete
Anziehrichtung
Senso di serraggio
Sentido de aperto
Kiristysuunta
Åtdragningsriktning
Tilstrammingsretning
Tilspændingsretning
Schroefriktning
Φορά σύσφιξης

	mm
H maxi	6.6
H mini	5.6

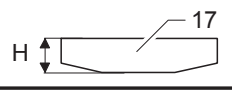
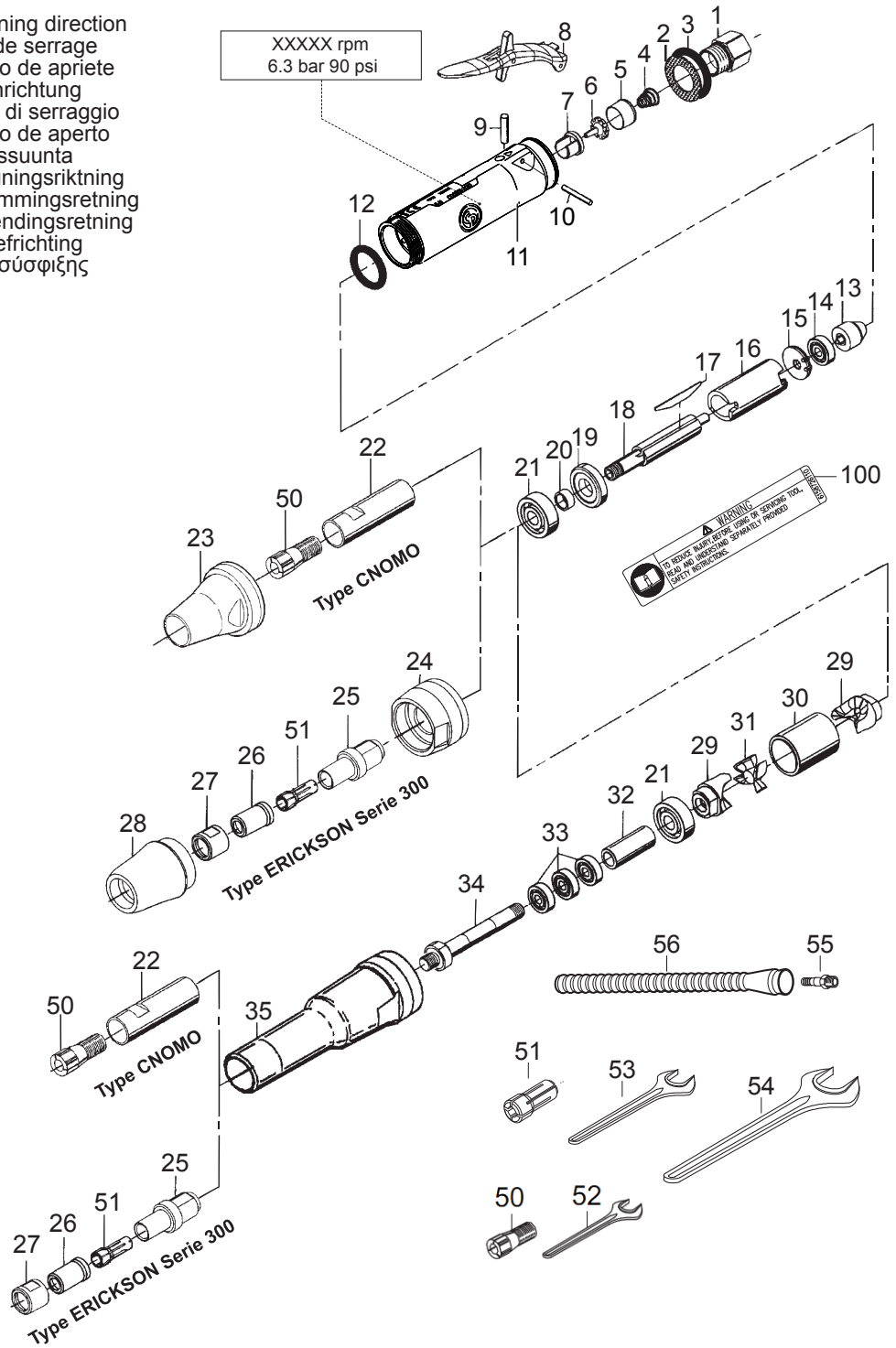

Item	Part No	Description	Qty
A	2050542053	AIR INLET KIT	
1	-	Adapter complete 1/4"	1
2	-	Silencer	1
3	-	O-Ring	1
B	2050542063	THROTTLE KIT	
4	-	Spring valve	1
5	-	Tube inlet	1
6	-	Throttle valve	1
7	-	Seat valve	1
C	2050542073	LEVER KIT	
8	-	Throttle lever	1
9	-	Pin	1
10	-	Pin	1
D	2050542083	REAR PLATE KIT	
14	-	Ball bearing	1
15	-	Rear end plate	1
E	2050542093	FRONT PLATE KIT	
19	-	Front end plate	1
21	-	Ball bearing CP3019-..	1
20	-	Collar rotor	2
F	2050542103	MOTOR KIT	
12	-	O-Ring	1
D	2050542083	REAR PLATE KIT	1
E	2050542093	FRONT PLATE KIT	1
16	400.134	Cylinder	1
17	434.55	Blade	3
18	426.92	Rotor	1
H	2050542113	COLLET HOLDER KIT	
25	-	Chuck-collet	1
G	2050541693	COLLET CLAMP KIT	1
I	2050542123	COUPLING KIT CP3019-..ES	
29	-	Fork coupling CP3019-..ES	2
30	-	Spacer CP3019-..ES	1
31	-	Cross coupling CP3019-..ES	1
J	2050542143	FRONT CAP KIT	
24	672.142	Front cap	1
28	225.46	Front cap protection	1

Item	Part No	Description	Qty
K	2050542153	EXTENSION KIT	
32	666.157	Sleeve spacer CP3019-..ES	1
33	758.114	Ball bearing CP3019-..ES	3
34	501.77	Spindle extension CP3019-..ES	1
35	566.459	Housing extension CP3019-..ES	1
L	2050542163	FLAT WRENCH KIT	
53	6158010030		
54	6158010320		
11	2050542193	Motor housing Kit	1
13	457.25	Governor 25K	1
13	457.26	Governor 31K	1
13	457.27	Governor 40K	1
13	457.28	Governor 20K	1
13	6154570450	Governor 18K	1
26	225.45	Bit Holding Gap	
27	607.143	Nut	
51	6155260590	Resilient collet series 300.	1
55	6157040190	1/4" air hose nipple for 8mm ID hose	1
56	6158751060	Exhaust hose L=31"	1
100	6158726110	Warning instruction	1
22	523.20	Chuck Collet	
23	672.138	Front Cap	
50	6155260460	CNOMO Collet Ø6	

TUNE UP KIT			
	8940174736	Including Part No. 2, 12, 17, 9, 10, 21, 33	1

	2050541923	Operator's manual
	6159948750	Safety instructions die-grinder
	2050541103	EC declaration die-grinder

**CP3019 CNOMO
Machined Routing kit**

Item	Part no.	Qty	Description
	6153960690	1	Complete kit
201	6155952310	1	Flange
202	6156071400	1	Adjusting Nut
204	6155421250	1	Machined routing guide

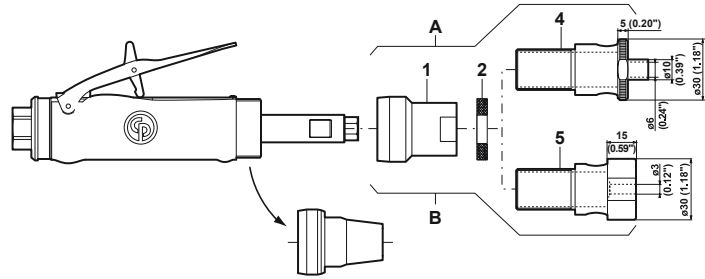
**CP3019 CNOMO
Blanked Routing kit**

Item	Part no.	Qty	Description
	6153960700	1	Complete kit
201	6155952310		Flange
202	6156071400		Adjusting Nut
205	6155421252		Blank routing guide

