

H		KC.. (mm)
H maxi		10.7
H mini		9.5

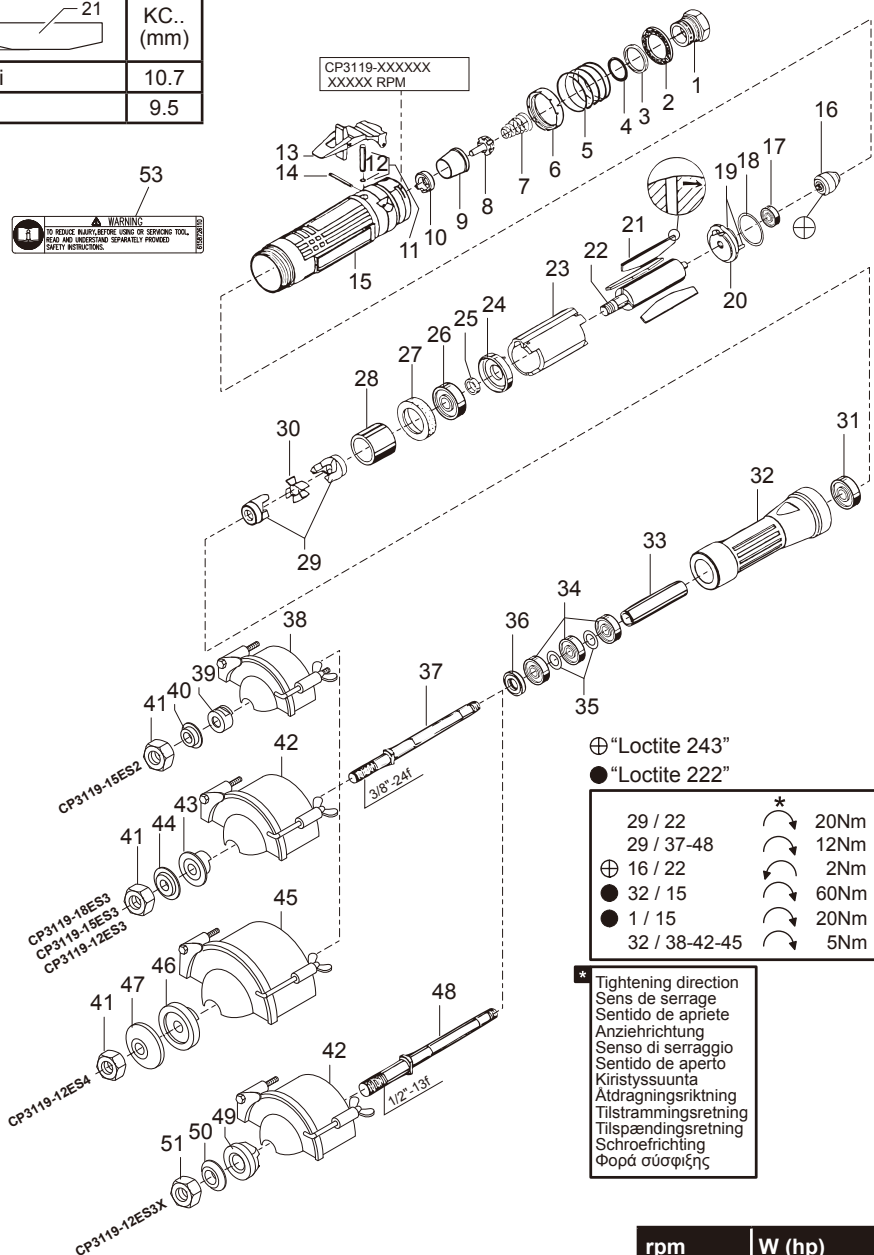
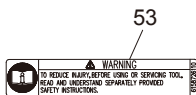

⊕ "Loctite 243"
● "Loctite 222"

29 / 22	↻*	20Nm
29 / 37-48	↻	12Nm
⊕ 16 / 22	↻	2Nm
● 32 / 15	↻	60Nm
● 1 / 15	↻	20Nm
32 / 38-42-45	↻	5Nm

* Tightening direction
Sens de serrage
Sentido de apriete
Anziehrichtung
Senso di serraggio
Sentido de aperto
Kiristysuunta
Atdragningsriktning
Tilstrammingsretning
Tilspændingsretning
Schroëfrichtung
Φορά σύσφιξης

	rpm	W (hp)
CP3119-12XXX	12000	900 (1.21)
CP3119-15XXX	15000	900 (1.21)
CP3119-18XXX	18000	900 (1.21)

Part n° 6159945150 Issu n° 01 Series C	CP3119-12ES3 / CP3119-12ES4 / CP3119-15ES2 / CP3119-15ES3 / CP3119-18ES3 / CP3119-12ES3X
--	---

Item	Part no.	Qty	Specific parts	Description
1	746.64	1		Adapter 3/8"
2	574.197	1		Silencer
3	643.75	1		Spacer
4	658.164	1		O-Ring
5	681.98	1		Spring
6	155.12	1		Valve
7	681.97	1		Spring-throttle
8	155.11	1		Throttle
9	430.23	1		Tube inlet
10	321.170	1		Seat throttle
11	312.80	1		Pin valve
12	658.198	1		O-Ring
13	321.154	1		Safety lever
14	637.145	1		Roll pin
15	6153962340	1		Motor housing
16	457.21	1	CP3119-15XXX	Governor 15K
16	457.22	1	CP3119-12XXX	Governor 12K
16	457.23	1	CP3119-18XXX	Governor 18K
17	6157581260	1		Ball bearing
18	656.148	1		Gasket
19	637.113	2		Roll pin
20	422.147	1		Rear plate
21	434.54	3		Vane
22	426.85	1		Rotor
23	400.132	1		Cylinder
24	420.130	1		Front plate
25	660.53	1		Spacer
26	753.64	1		Ball bearing
27	645.132	1		Spacer
28	666.145	1		Spacer
29	575.100	2		Coupling fork
30	575.101	1		Coupling
31	753.10	1		Ball bearing
32	566.432	1		Housing
33	666.142	1		Spacer
34	758.97	3		Ball bearing
35	666.141	2		Spacer
36	640.65	1		Washer
37	501.74	1	CP3119-15ES2 / CP3119-15ES3 / CP3119-18ES3 / CP3119-12ES3 CP3119-12ES4	Shaft 3/8" UNF
38	6155041500	1	CP3119-15ES2	Wheel guard
39	6155031260	1	CP3119-15ES2	Rear flange
40	6155020430	1	CP3119-15ES2	Front flange

Item	Part no.	Qty	Specific parts	Description
41	6156080440	1	CP3119-15ES2 / CP3119-15ES3 / CP3119-18ES3 / CP3119-12ES3 / CP3119-12ES4	Hex nut
42	6155041510	1	CP3119-18ES3 / CP3119-15ES3 / CP3119-12ES3	Guard 3"
43	6155031250	1	CP3119-18ES3 / CP3119-15ES3 / CP3119-12ES3	Rear flange
44	6155020130	1	CP3119-18ES3 / CP3119-15ES3 / CP3119-12ES3	Front flange
45	6155041520	1	CP3119-12ES4	Guard 4"
46	6155031310	1	CP3119-12ES4	Rear flange
47	6155020630	1	CP3119-12ES4	Front flange
48	501.73	1	CP3119-12ES3X	Shaft 1/2" UNC
49	6155031270	1	CP3119-12ES3X	Rear flange
50	6155020440	1	CP3119-12ES3X	Front flange
51	6156080450	1	CP3119-12ES3X	Hex nut
53	6158726110	1		Warning instruction

ACCESSORIES INCLUDED

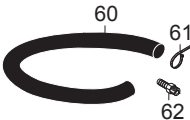
	Item	Part no.	Qty	Description
	60	6158751130	1	Exhaust hose L=60"
	61	6158734150	1	Hose clamp
	62	6157040170	1	Air hose nipple 3/8" for 3/8" ID hose

CP3119-15ES2	Item	Part no.	Qty	Description
	63	6158010320	1	Flat wrench 11/16"
	64	6158010740	1	Flat wrench 9/16"

CP3119-12ES3 / CP3119-15ES3 CP3119-18ES3 / CP3119-12ES4	Item	Part no.	Qty	Description
	64	6158010740	1	Flat wrench 9/16"
	65	6158010760	1	Flat wrench 3/4"

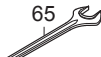
CP3119-12ES3X	Item	Part no.	Qty	Description
	65	6158010760	1	Flat wrench 3/4"

OPTIONAL ACCESSORIES

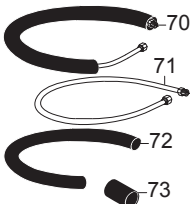
	Item	Part no.	Qty	Description
	70	6153961660	1	Complete silencer kit
	71	6158702100	1	Inlet hose ass. L=67"
	72	6158751160	1	Reinforced cloth lined exhaust hose L=30"
	73	6155704710	1	Insulation sleeve

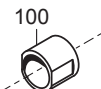
CP3119-15ES2 / CP3119-xxES3	Item	Part no.	Qty	Description
	100	6155035160	1	Cone wheel spacer for 3/8" spindle

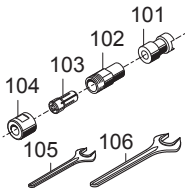
	Item	Part no.	Qty	Description
	101	6156661490	1	Spacer for collet holder
	102	6155230230	1	Collet holer
	103	6155260610	1	Serie 200 resilient collet Ø1/8"
	103	6155260620	1	Serie 200 resilient collet Ø5,2 to 6mm
	103	6155260630	1	Serie 200 resilient collet Ø1/4"
	103	6155260640	1	Serie 200 resilient collet Ø7,2 to 8mm
	103	6155260650	1	Serie 200 resilient collet Ø3/8"
	104	6156071440	1	Nut
	105	6158010050	1	Flat wrench 14mm
	106	6158010760	1	Flat wrench 3/4"